

# 75 : G47

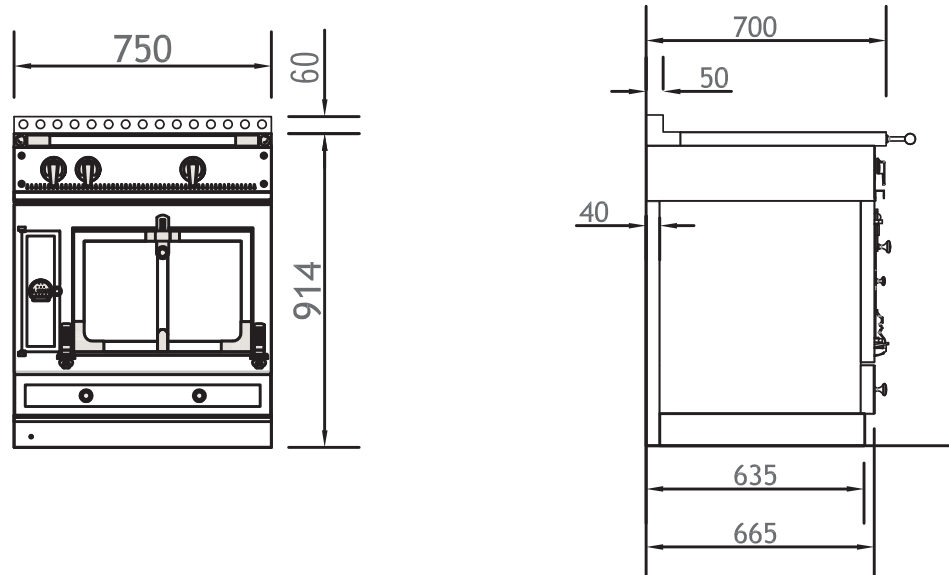

The Chateau 75 is the baby of the family, a small but stately range which can satisfy the La Cornue passion. Nearly 30" in width, this range features one vaulted oven, either gas or electric, and five rangetop configurations.



## SPECIFICATIONS

### CHÂTEAU 75: G47

750 W x 700 D x 920 H (mm)  
 29.5 W x 27.6 D x 36 H (inches)  
 Approx. 290 lb. uncrated, 600 lb. crated  
 Choice of 5 top configurations  
 All-electric range available  
**Starting from \$27,000**

#### STANDARD FEATURES INCLUDE:

- 1 Vaulted Gas Oven with Electric Broiler 16.8W x 19.8D x 11.8H – 2.3 cubic feet (left)
- 1 Vaulted Electric Oven with Electric Broiler 16.8W x 17.5D x 11.8H – 2.0 cubic feet (right)

### CHÂTEAU RANGETOP 75: T47

750 W x 700 D x 200 H (mm)  
 29.5 W x 27.6 D x 7.9 H (inches)  
 Approx. 130 lb. uncrated, 250 lb. crated  
 Choice of 5 top configurations  
**Starting from \$10,400**

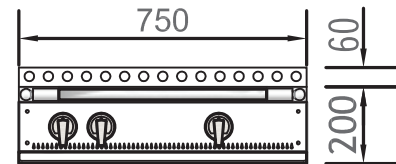

## LE CHÂTEAU OPTIONS

*Enamel and Metal Body Options:* Chateau ranges are available in a variety of 50 enamel or metal body finishes, and can also be customized in a one-of-a-kind color. Prices may vary depending on colors selected.

*Trim Options:* Polished Brass, Brushed Brass, Brushed Stainless Steel, Brushed Nickel, Polished Chrome, Polished Copper, Matte Black, Black Shiny Chrome, Matte Bronze, Brushed Copper and Polished Stainless Steel. Prices may vary depending on trims selected.



# 75 : G47

## RANGETOP CONFIGURATIONS

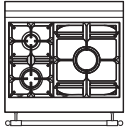

**75 US B1**  
2 gas burners (small burner at the back)  
1 maxi burner

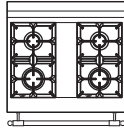

**75 US B2**  
2 gas burners (small burner at the back)  
2 gas burners (small burner at the back)

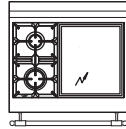

**75 US B3**  
2 gas burners (small burner at the back)  
1 large electric Teppan-Yaki

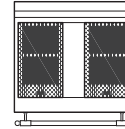

**75 US BA\***  
2 induction plates  
2 induction plates

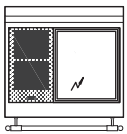

**75 US BB\***  
2 induction plates  
1 large electric Teppan-Yaki

\*Induction element incurs an upcharge of \$2,200 per element

## CHÂTEAU SERIES HOODS

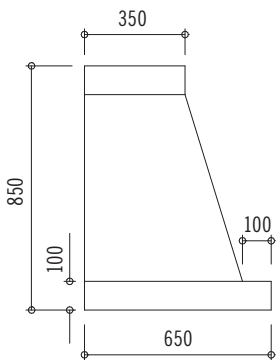

**Standard Configuration Wall Hood**  
Side View

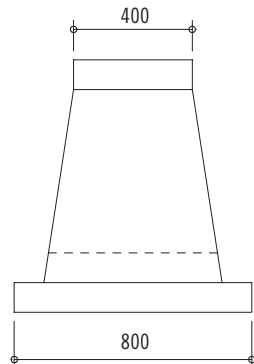

**Standard Configuration Island Hood**  
Side View

Since every installation is unique, Hotte Chateau hoods are sold without a blower system, as a shell-only. Motorized hoods are available for standard wall-mounted Hotte Chateau. Please contact your local HVAC contractor to discuss specific installation requirements. La Cornue does offer standard Chateau hood models with blower option, as noted below. For custom inserts, please inquire with Middleby Residential directly.

Traditional wall mounted hood. Island Hoods are also available. Custom Hoods available by quote. Hood height may be increased up to 1500 mm/ 59 inches by adding height to the upper band (total maximum height would be 2250 mm/88.5 inches).

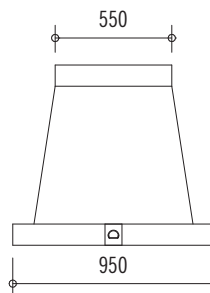

**HOTTE CHATEAU 75: H95T0**  
950 W x 850 H x 650 D (mm)  
37.4 W x 33.5 H x 25.6 D (inches)  
**Shell-Only Starting from \$8,200**  
**Motorized Hood Starting from \$10,800**  
**Island configuration: H95C0**  
**Starting from \$14,100**

\*Motorized Factory installed blower and liner are available for the Chateau Hotte wall mounted hoods only. Motorized hoods include a 1200 CFM blower for all two oven cookers and a 600 CFM blower for all one oven cookers. They also include, liner, lights, mesh magnetic filters and a remote control.